

Battery Charger (for lead-acid battery)

Important Safety Instructions

⚠ WARNING Shock and Energy Hazards

Be sure to read the safety guidelines and pay attention to all cautions and warnings throughout the installation procedure.

The installer is responsible for ensuring compliance with the installation codes for your particular application. Disconnect all sources of AC and DC power before proceeding.

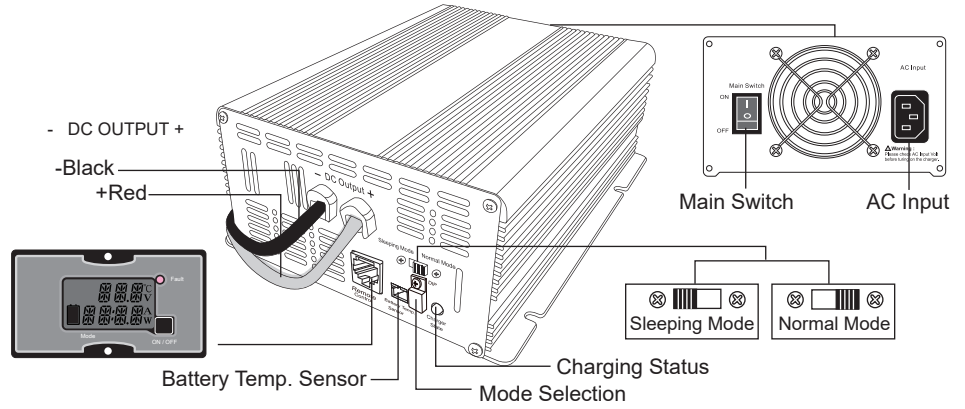

Model	HT-C-30-12		HT-C-15-24	
INPUT				
Voltage range	100 ~ 240VAC			
Frequency range	50/60Hz			
Efficiency	>=85%			
Power factor	1.0 at full load (+/-5%)			
Input socket	IEC plug			
OUTPUT				
Mode Selection	Mode 1	Mode 2 *1	Mode 1	Mode 2 *1
Bulk Stage	14.4V/30A	13.5V/30A	28.8V/15A	27V/15A
Absorption stage	14.4V/30A max.	13.5V/30A	28.8V/15A max.	27V/15A
Float stage	13.5V/2A max.	13.5V/30A	27V/1A max.	27V/15A
Aging (sulfated) battery	When the battery <9V.		When the battery <18V.	
	14.4V / 2A	13.5V / 2A	28.8V / 1A	27.0V / 1A
Recommended battery capacity	75 ~ 250Ah (12V)		45 ~ 150Ah (24V)	
Leakage current from battery	<1mA		<1mA	
Sleeping Mode Function	YES (5A current output only)	/	YES (2.5A current output only)	/
PROTECTION				
Over temperature	55°C±5°C			
Output terminal reverse	By fuse			
Overload	YES			
Output short circuit	YES			
Microprocessor check	YES			
ENVIRONMENT				
WORKING TEMP.	-15°C ~ +45°C			
WORKING HUMIDITY	20 ~ 90% RH non-condensing			
STORAGE TEMP., HUMIDITY	-30°C ~ +70°C (-22°F ~ +158°F) , 10 ~ 95% RH			
TEMP. COEFFICIENT	±0.05%°C (0 ~ 50°C)			
OTHER				
Remote control	YES			
Dimension (L x W x H)	235 x 179 x 90mm			
Weight	2.4kgs			

*1. Mode 2: ⚠ DON'T charge the battery! *2. The above spec. ±0.5V for 12V spec.; ±1.0V for 24V spec.; Amp. ±10% is acceptable.

⚠ Note: Specifications subject to change without notice.

- Do not expose the charger to rain, snow, spray, or bilge water. To reduce risk of fire hazard, do not cover or obstruct the ventilation openings. Do not install the charger in a zero-clearance compartment. Overheating may result.
- Before using the charger, read all instructions and cautionary markings on the charger, the batteries, and all appropriate sections of this guide.
- Use only attachments recommended or sold by the manufacturer. Doing otherwise may result in a risk of fire, electric shock, or injury to persons.
- Do not disassemble the charger. Attempting to service the unit yourself may result in a risk of electrical shock or fire. Internal capacitors remain charged after all power is disconnected.
- This appliance is not intended for use by persons (including children) with reduced physical, sensory or mental capabilities, or lack of experience and knowledge, unless they have been given supervision or instruction concerning use of the appliance by a person responsible for their safety.
- Children should be supervised to ensure that they do not play with the appliance.
- The charger must be provided with an equipment-grounding conductor connected to the AC input ground.
- To reduce the risk of electrical shock, disconnect both AC and DC power from the charger before attempting any maintenance or cleaning or working on any circuits connected to the charger. Turning off controls will not reduce this risk.
- Do not operate the charger if it has received a sharp blow, been dropped, or otherwise damaged in any way.
- To avoid a risk of fire and electric shock, make sure that existing wiring is in good condition and that wire is not undersized. Do not operate the charger with damaged or substandard wiring.

Installation Location: Physical requirements for installation

Condition	Description
Clean	Do not expose the charger to metal filings or any other form of conductive contamination. The presence of conductive contamination can cause damage and void your warranty.

Cool	For best performance, the ambient air temperature should be between 5°F (-15°C) and 113°F (45°C)- the cooler the better. At higher ambient temperatures, the output current will be automatically reduced to protect the charger from high internal temperatures.
Dry	The unit is intended for use in a dry location. Do not allow water or other fluids to drip or splash on the charger. Do not mount the charger in an area subject to rain, spray or splashing bilge water.
Maintenance	You should clean the exterior of the unit periodically with a dry cloth to prevent accumulation of dust and dirt. At the same time, tighten the screws on the DC input terminals.
Safe	This battery charger is Ignition Protected, so it can be installed in areas containing gasoline tanks or fittings which usually require Ignition Protected equipment. It is safest not to install electrical equipment in these areas.
Ventilated	Allow at least 4 inches (10 cm) of clearance around all sides of the charger for air flow. Ensure that the ventilation openings on the unit are not obstructed. If mounting in a compartment, ventilate the compartment with louvres or cut-outs to prevent overheating.
Close to AC junction box	Avoid the use of extended wire lengths if possible.
Close to batteries	Avoid excessive cable lengths and use the recommended wire lengths and sizes. Undersized or overly long cables may affect charging accuracy.

Installation Illustration

- Before charging, read the instructions; for indoor use only. Disconnect the supply before making or breaking the connections to the battery.

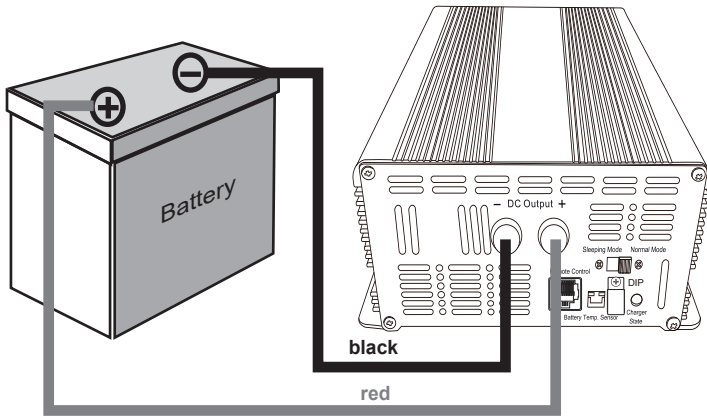

WARNING

Explosive gases; Prevent flames and sparks; Provide adequate ventilation during charging. Include a warning against recharging non-rechargeable batteries. If the supply cord is damaged, it must be replaced by a special cord or assembly available from the manufacturer or it's service agent.

Explosive gas precautions

1. The charger have been approved as Ignition Protected. They may be installed in areas containing gasoline tanks and fittings which require Ignition Protected equipment. It is safest not to install electrical equipment in these areas.
2. To reduce the risk of battery explosion, follow these instructions and those published by the battery manufacturer and the manufacturer of the equipment in which the battery is installed.
3. Working in the vicinity of lead-acid batteries is dangerous. Batteries generate explosive gases during normal operation. Therefore you must read this guide and follow the instructions exactly before installing or using your charger.

Isolated Design

The DC battery charging circuits of this charger are galvanically isolated by a transformer from the AC power circuits. This feature reduces the risk of electric shock .

Charging volt graph (0:OFF ■)

	Mode 1 (100)	Battery charger mode.	
	Mode 2 (003)	Power supply mode.	

Charger Display :

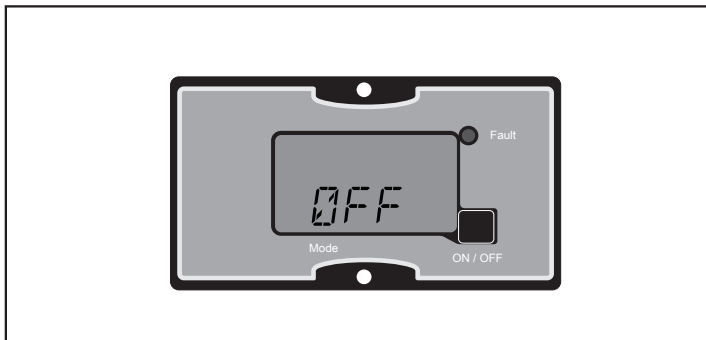

1. OFF

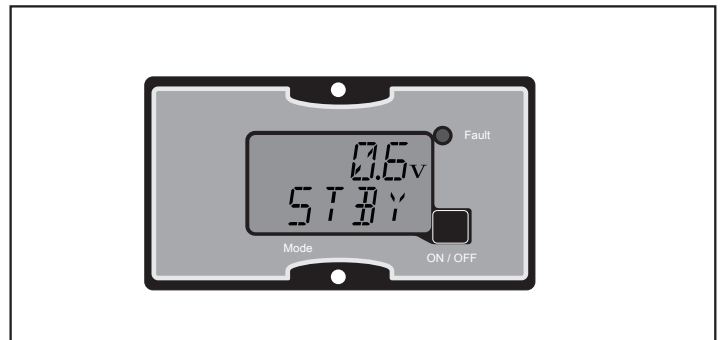

2. Mode 1 : no battery connected. / the battery is broken.

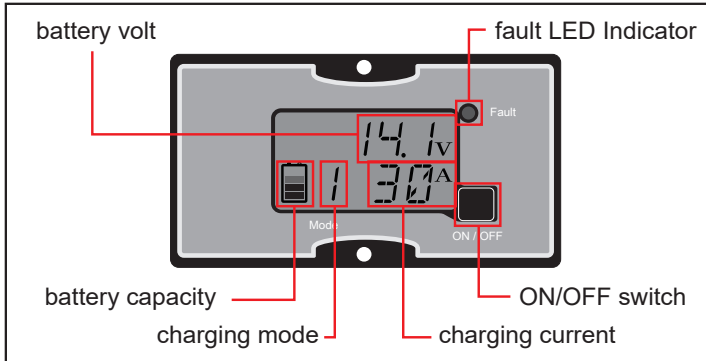

3. Mode 1: while charging.

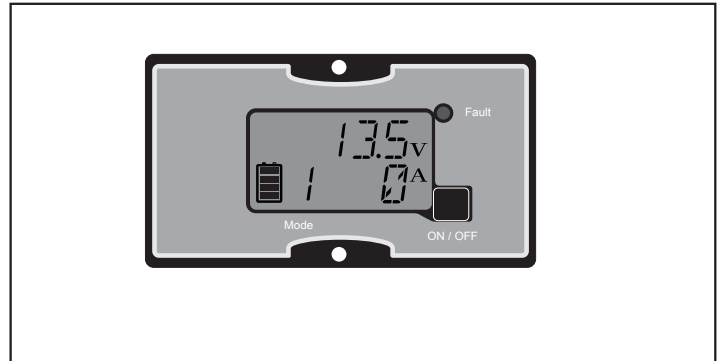

4. Mode 1: float stage.

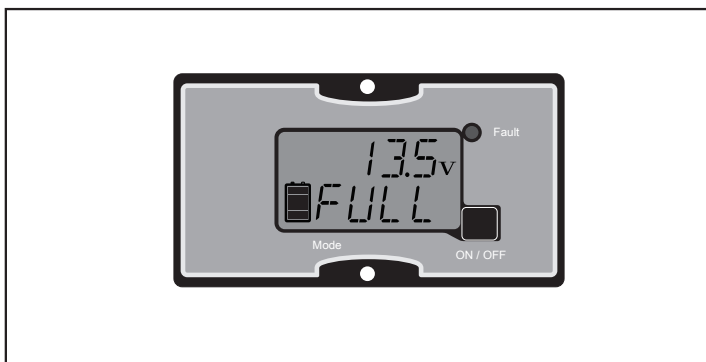

5. Mode 1: battery full.

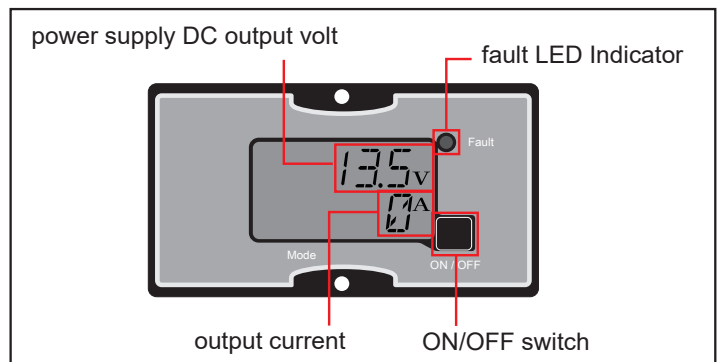

6. Mode 2: power supply mode.

**** If overload, the output volt would go down gradually, according to the load current. ****

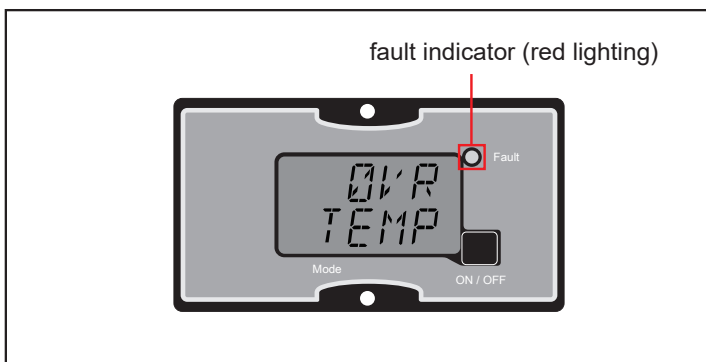

7. Over temperature protection & low input volt protections.

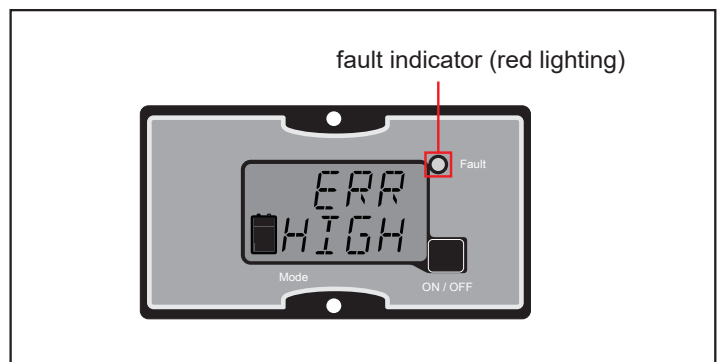

8. High battery volt protection.



Do not dispose this product as unsorted municipal waste. Collection of such waste separately for special treatment is necessary.

This product must not be disposed together with the domestic waste.

This product has to be disposed at an authorized place for recycling of electrical and electronic appliances.

By collecting and recycling waste, you help save natural resources, and make sure the product is disposed in an environmental friendly and healthy way.